

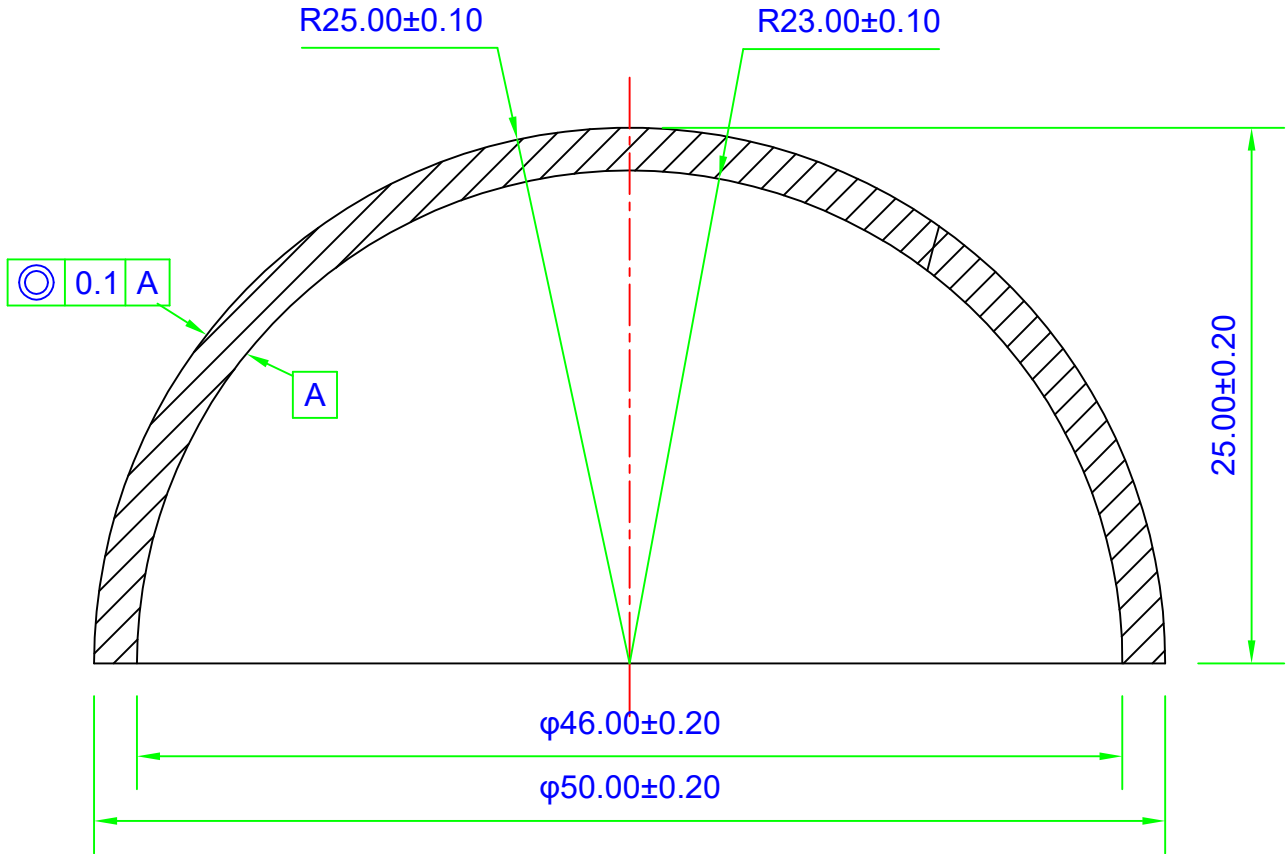







REVISIONS			
LTR	ECD	DATE	APPROVED

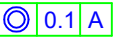

SURFACE 1	MATERIAL	SURFACE 2
R = 25.00 ±0.10mm 3/ 10(5)  4/  0.1 A 5/ 60-40 Chamfer: 0.2-0.5mm ×45°	UV Fused Silica nd= vd= 0/ 1/ 2/ 6/	R = 23.00 ±0.10mm 3/ 10(5)  4/  A 5/ 60-40 Chamfer: 0.2-0.5mm ×45°

PROTECTIVE CHAMFERS AS NEEDED	ALL DIMENSIONS IN MM UNLESS OTHERWISE STATED  			 MANUFACTURER FROM CHINA	
NOTICE: DIMENSIONS ARE FOR REFERENCE ONLY	IF IN DOUBT -ASK	Name	DATE	TITLE	CATALOG OF CLZ OPTICAL DOMES 50mm DIA, 2mm THICK, UNCOATED UV Fused Silica DOME
	TOLERANCE (UNLESS OTHERWISE STATED)	DESIGN	Royan Luo		
FOR INFORMATION ONLY: DO NOT MANUFACTURE PARTS TO THIS DRAWING	.X ± FRACTION ± 	CHECKED	Bonnie He	6/11/2016	SIZE
	.XX ± ANGLE ±	POS			
	.XXX ± GENERAL ±	ENG APPR			DWG NO
		MFG APPR			