

4





3

2

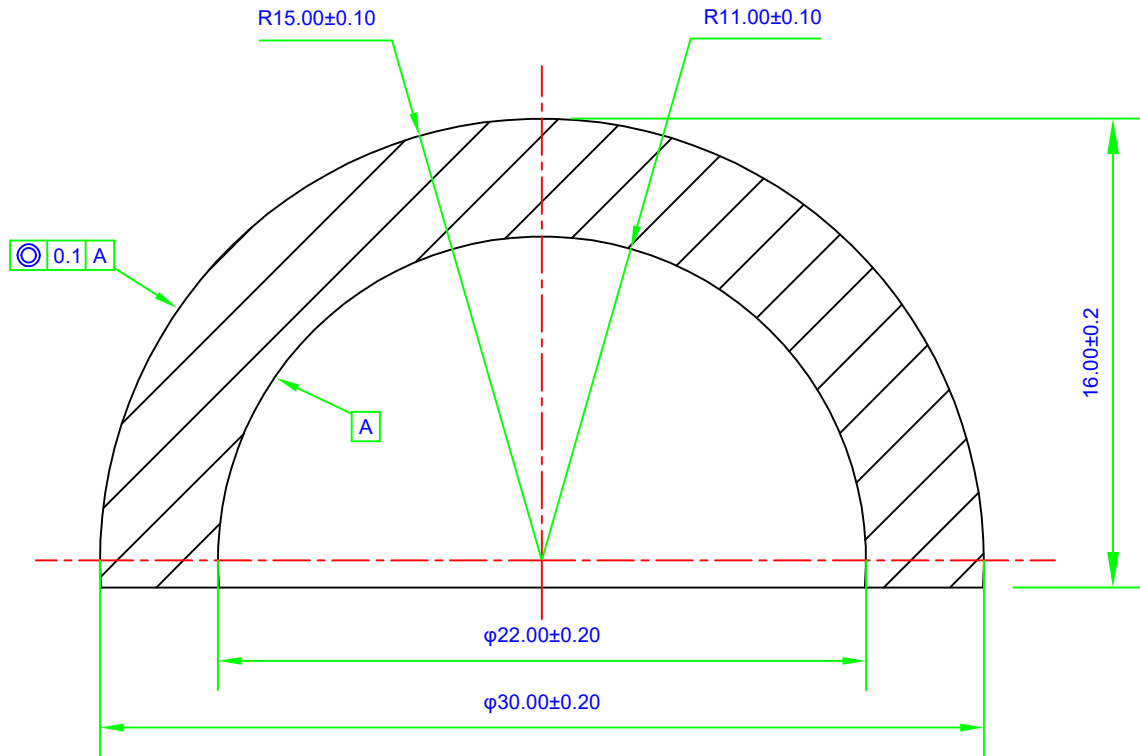
1

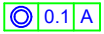
REVISIONS			
LTR	ECD	DATE	APPROVED



SURFACE 1		MATERIAL		SURFACE 2																		
R = 15 ±0.10mm 3/ 10(5)  4/  0.1 A 5/ 60-40 Chamfer: 0.2-0.5mm ×45°		H-K9L (CDGM) nd=1.51680 Vd=64.20 0/ 1/ 2/ 6/		R = 11 ±0.10mm 3/ 10(5)  4/  A 5/ 60-40 Chamfer: 0.2-0.5mm ×45°																		
PROTECTIVE CHAMFERS AS NEEDED		ALL DIMENSIONS IN MM UNLESS OTHERWISE STATED 		 MANUFACTURER FROM CHINA																		
NOTICE. DIMENSIONS ARE FOR REFERENCE ONLY		IF IN DOUBT -ASK				<table border="1"> <thead> <tr> <th>DESIGN</th> <th>Name</th> <th>DATE</th> </tr> </thead> <tbody> <tr> <td>CHECKED</td> <td>Lucas Luo</td> <td>6/08/2016</td> </tr> <tr> <td>POS</td> <td>Eva Cheng</td> <td>6/10/2016</td> </tr> <tr> <td>ENG APPR</td> <td> </td> <td> </td> </tr> <tr> <td>MFG APPR</td> <td> </td> <td> </td> </tr> </tbody> </table>	DESIGN	Name	DATE	CHECKED	Lucas Luo	6/08/2016	POS	Eva Cheng	6/10/2016	ENG APPR			MFG APPR			<table border="1"> <thead> <tr> <th>TITLE</th> </tr> </thead> <tbody> <tr> <td>CATALOG OF CLZ OPTICAL DOMES 30mm DIA, 4mm THICK, UNCOATED H-K9L DOME</td> </tr> </tbody> </table>
DESIGN	Name	DATE																				
CHECKED	Lucas Luo	6/08/2016																				
POS	Eva Cheng	6/10/2016																				
ENG APPR																						
MFG APPR																						
TITLE																						
CATALOG OF CLZ OPTICAL DOMES 30mm DIA, 4mm THICK, UNCOATED H-K9L DOME																						
FOR INFORMATION ONLY: DO NOT MANUFACTURE PARTS TO THIS DRAWING		<table border="1"> <thead> <tr> <th>TOLERANCE (UNLESS OTHERWISE STATED)</th> <th>NAME</th> <th>DATE</th> </tr> </thead> <tbody> <tr> <td>.X ± FRACTION ±</td> <td> </td> <td> </td> </tr> <tr> <td>.XX ± ANGLE ±</td> <td> </td> <td> </td> </tr> <tr> <td>.XXX ± GENERAL ±</td> <td> </td> <td> </td> </tr> </tbody> </table>		TOLERANCE (UNLESS OTHERWISE STATED)	NAME	DATE	.X ± FRACTION ±			.XX ± ANGLE ±			.XXX ± GENERAL ±			<table border="1"> <thead> <tr> <th>SIZE</th> </tr> </thead> <tbody> <tr> <td>A4</td> </tr> </tbody> </table>	SIZE	A4	<table border="1"> <thead> <tr> <th>DWG NO</th> </tr> </thead> <tbody> <tr> <td>CLZ-DOME-30F</td> </tr> </tbody> </table>	DWG NO	CLZ-DOME-30F	
TOLERANCE (UNLESS OTHERWISE STATED)	NAME	DATE																				
.X ± FRACTION ±																						
.XX ± ANGLE ±																						
.XXX ± GENERAL ±																						
SIZE																						
A4																						
DWG NO																						
CLZ-DOME-30F																						